

TRUFLAME – GAS DUCK ROASTER

- The double-layered exterior body improves heat-insulation.
- Stainless steel with the heat-resistant reflective board, strong and durable, energy-saving, provides even heat distribution and retention during cooking.
- Equipped with a safety valve to prevent gas leaks.
- High-quality everlasting pilot, ion sensor flame failure device, long service life.
- Electronic ignition connected with safety valve, easy to operate.



CONSTRUCTION & FEATURES

DUCK ROASTER

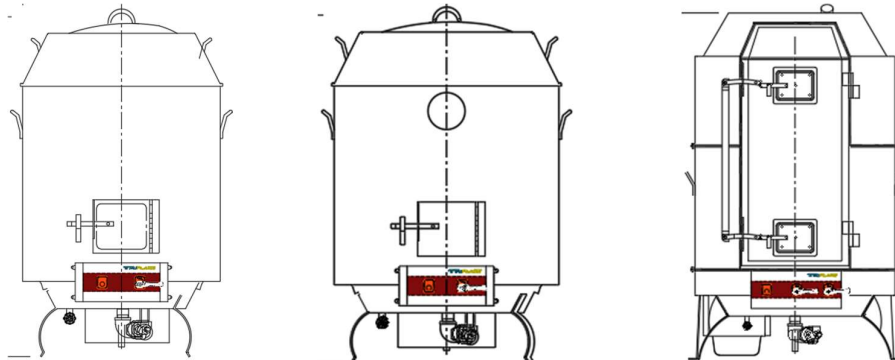

SPECIFICATIONS

Model	TFA-DR870	TFA-DR970	TFA-DR1000
Dimension (mm)	ø870 X 1500H	ø970 X 1500H	ø1000 X 1680H
Heat Load (kW)	16kW	16kW	16kW
Gas Connection	0.3 bar/ DN 20	0.3 bar/ DN 25	0.3 bar/ DN 20

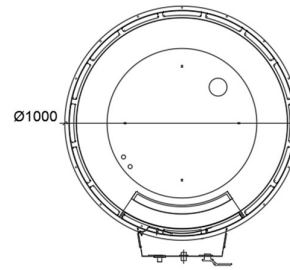
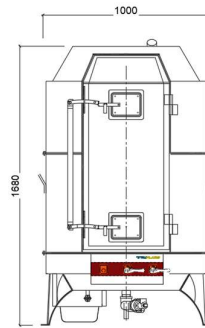
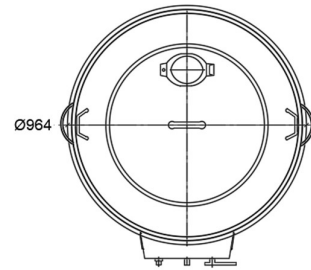
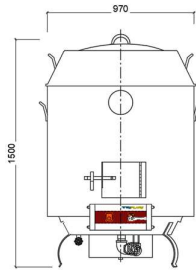
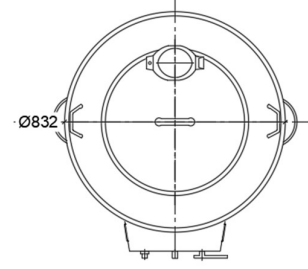
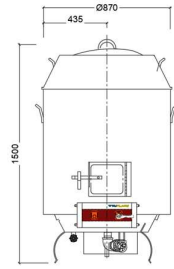

TECHNICAL DRAWINGS